

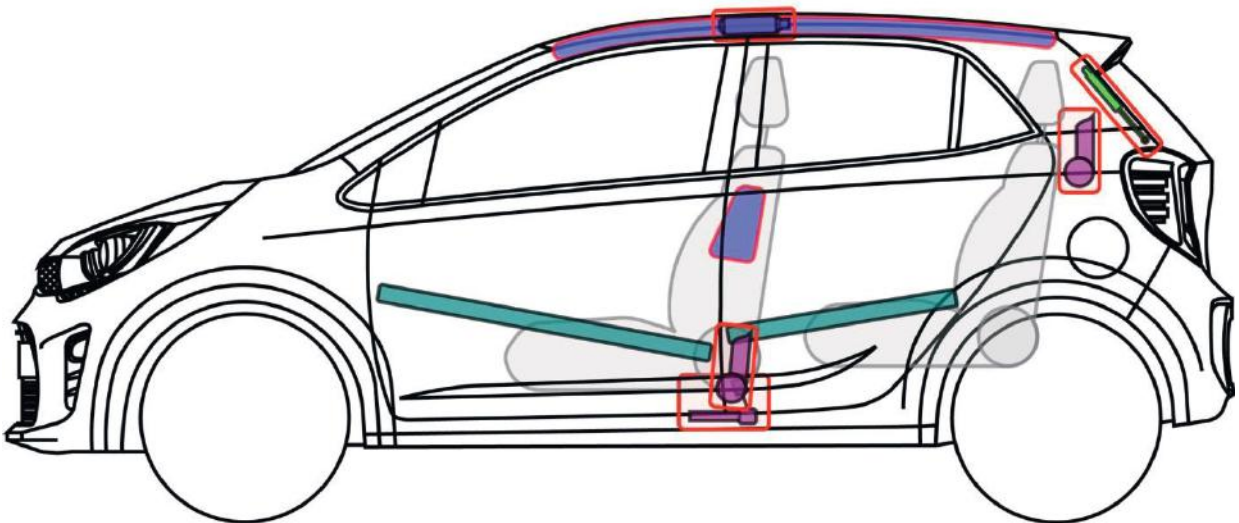

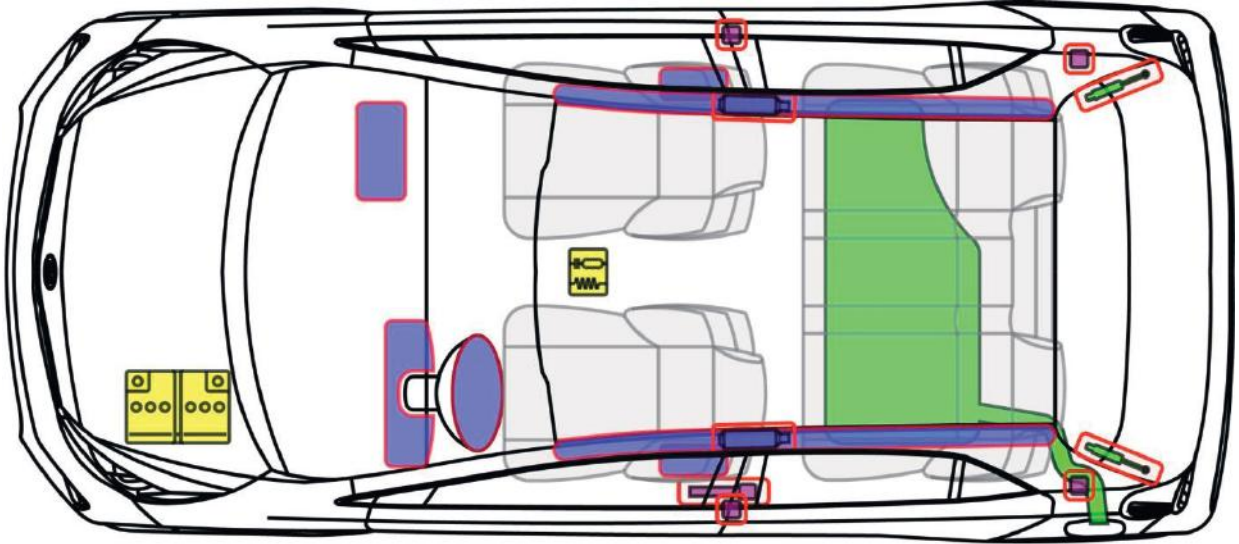









Picanto (JA)

5-Türer, ab 2017

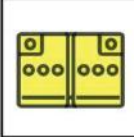

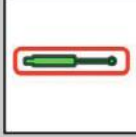
Legende

	Airbag		Karosserie- verstärkung		Steuergerät
	Gas- generator		Überroll- schutz		12 V Batterie
	Gurt- straffer		Gasdruck- dämpfer		Kraftstoff- tank

Picanto







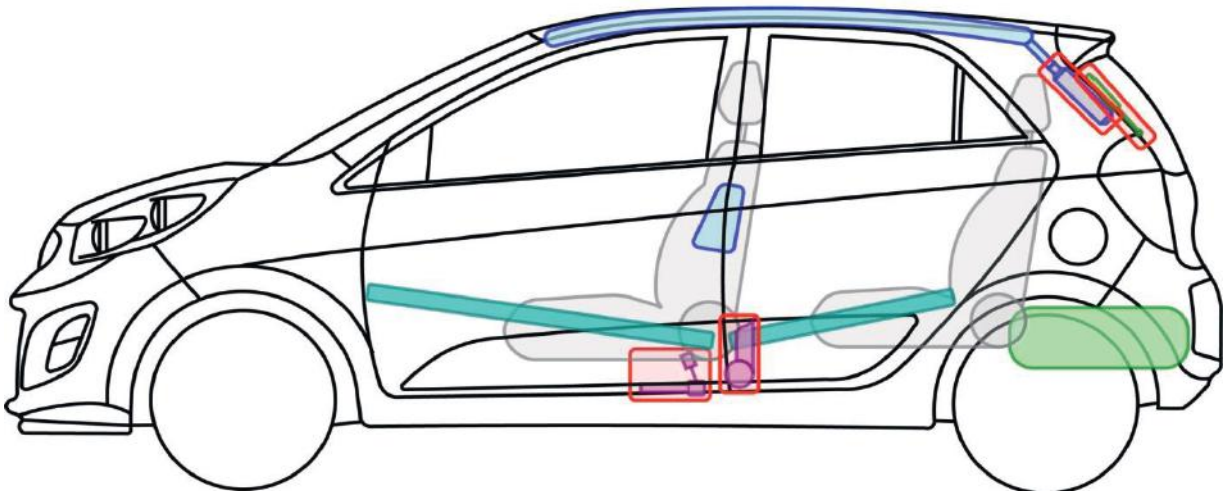
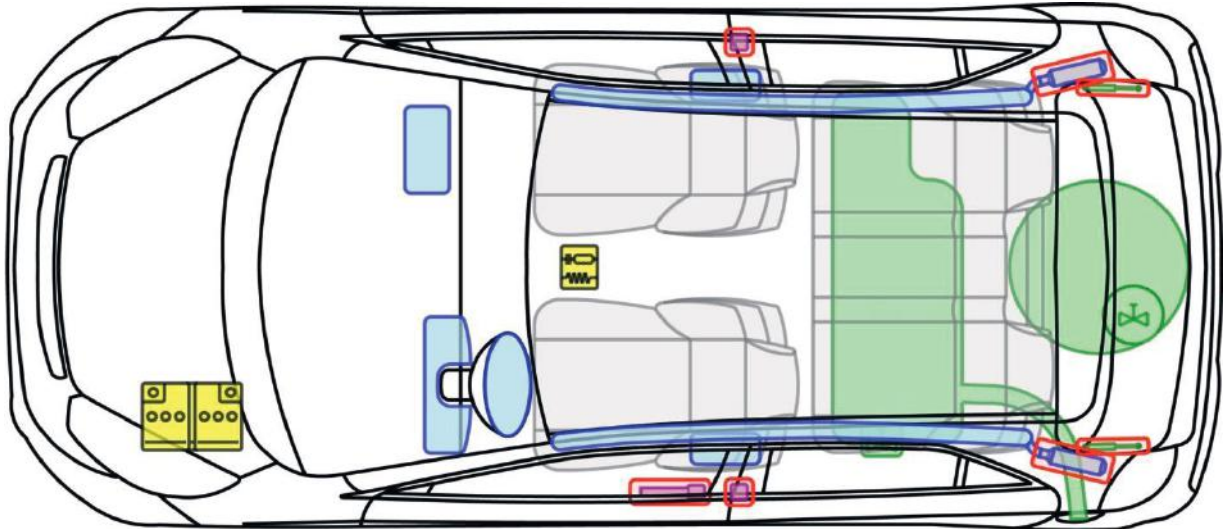

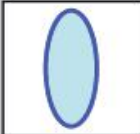

Picanto (TA)

5-Türer, LPG, 2011-2017
inklusive Facelift



Legende

	Airbag		Karosserie- verstärkung		Steuergerät
	Gas- generator		Überroll- schutz		Batterie
	Gurt- straffer		Gasdruck- dämpfer		Kraftstoff- tank

Picanto







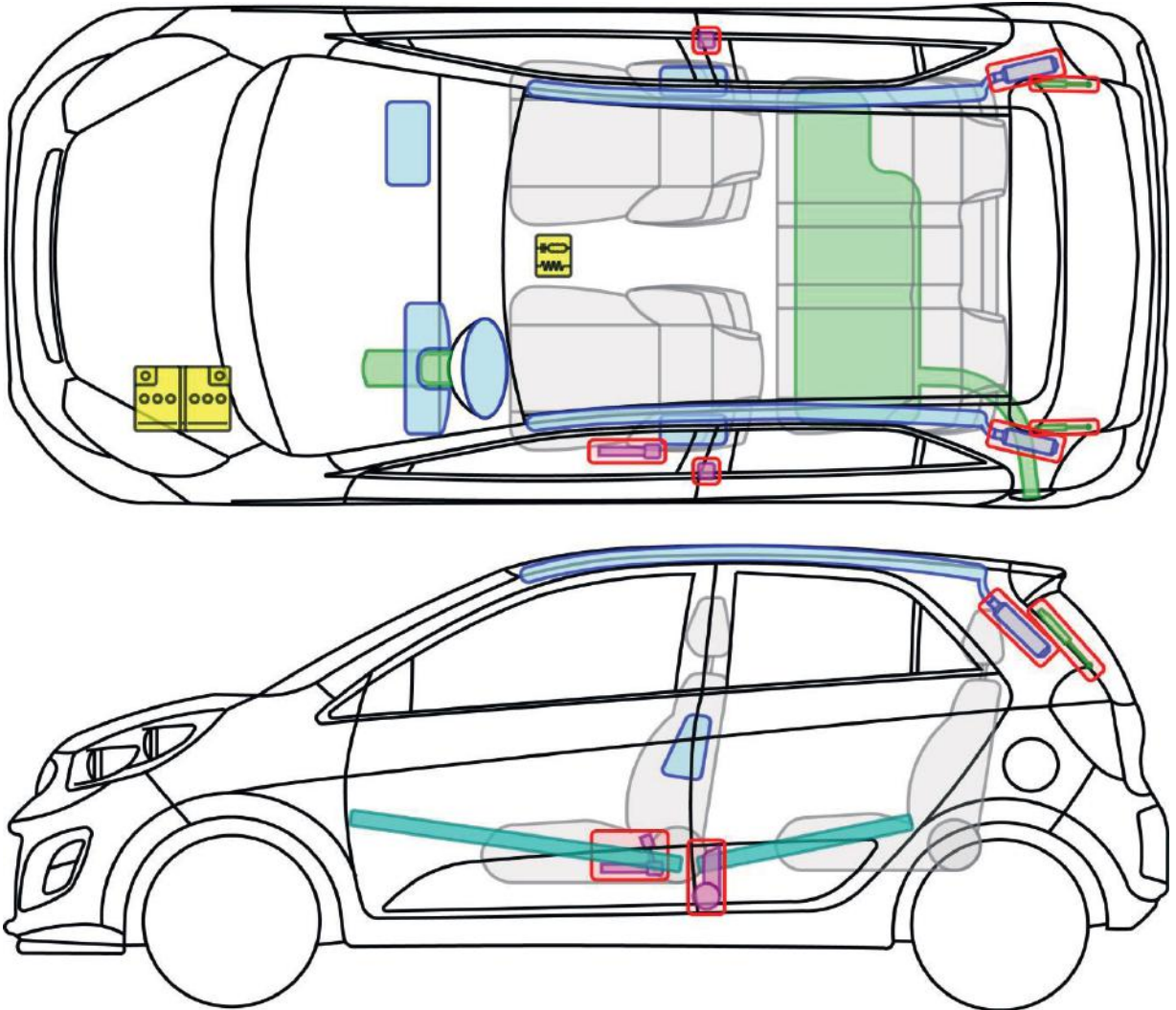

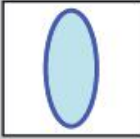

Picanto (TA)

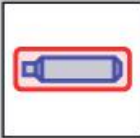
5-Türer, 2011-2017
inklusive Facelift

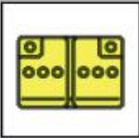

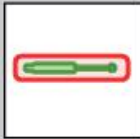
Legende

	Airbag		Karosserie- verstärkung		Steuergerät
	Gas- generator		Überroll- schutz		Batterie
	Gurt- straffer		Gasdruck- dämpfer		Kraftstoff- tank

Picanto







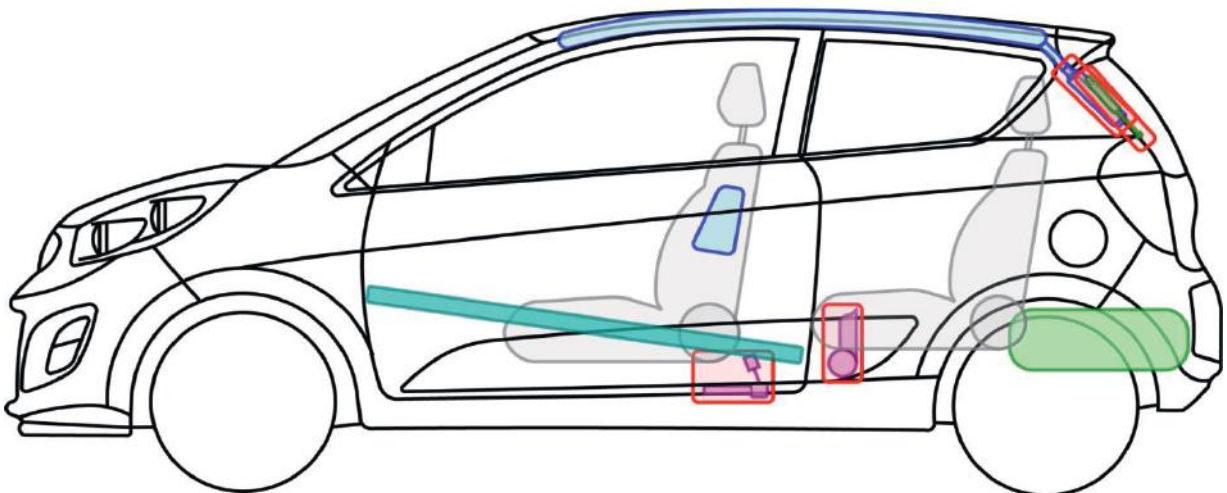
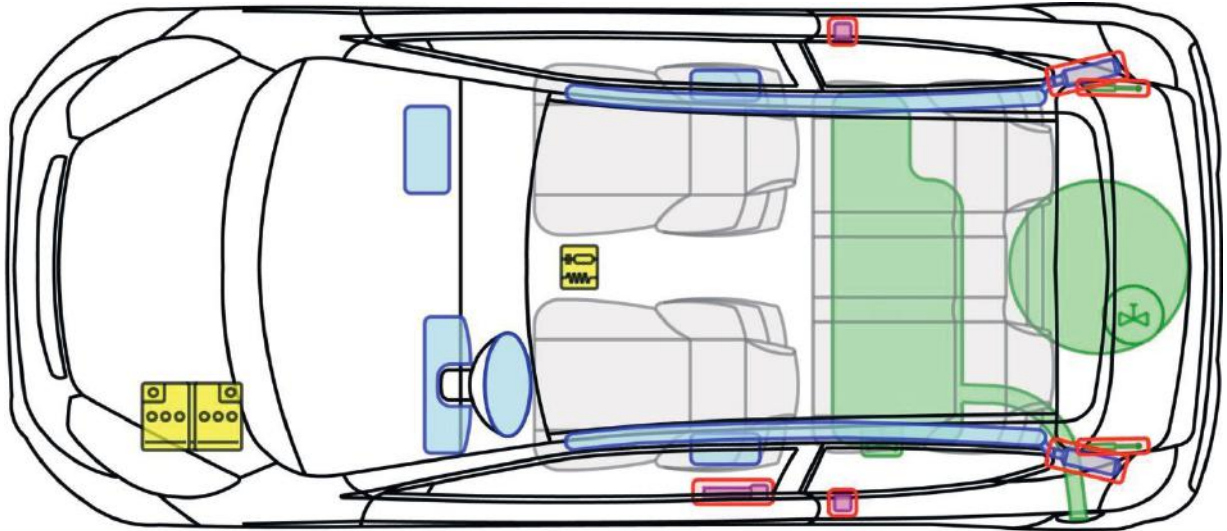

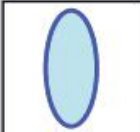

Picanto (TA)

3-Türer, LPG, 2011-2017
inklusive Facelift



Legende

	Airbag		Karosserie- verstärkung		Steuergerät
	Gas- generator		Überroll- schutz		Batterie
	Gurt- straffer		Gasdruck- dämpfer		Kraftstoff- tank

Picanto







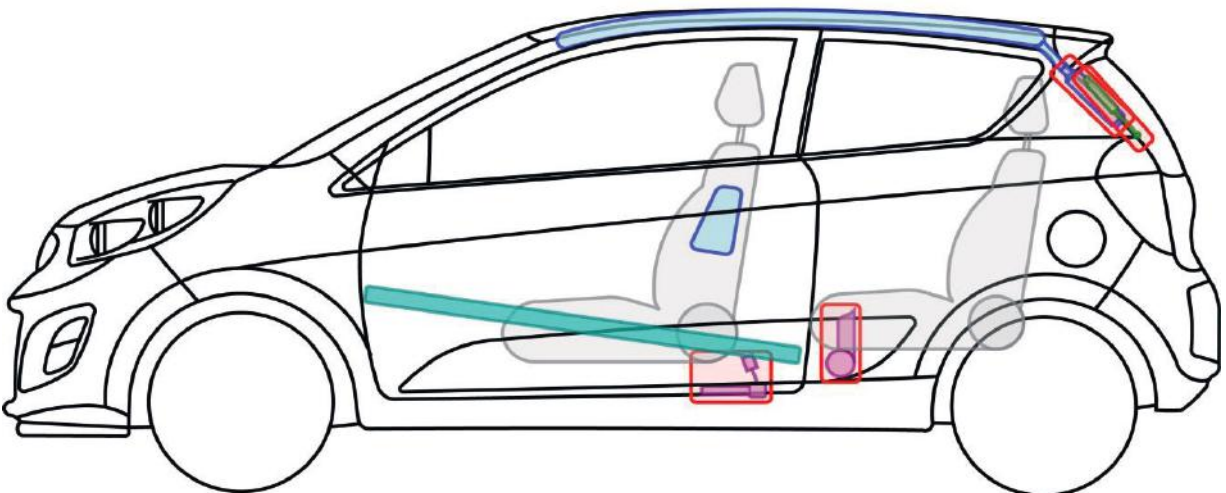
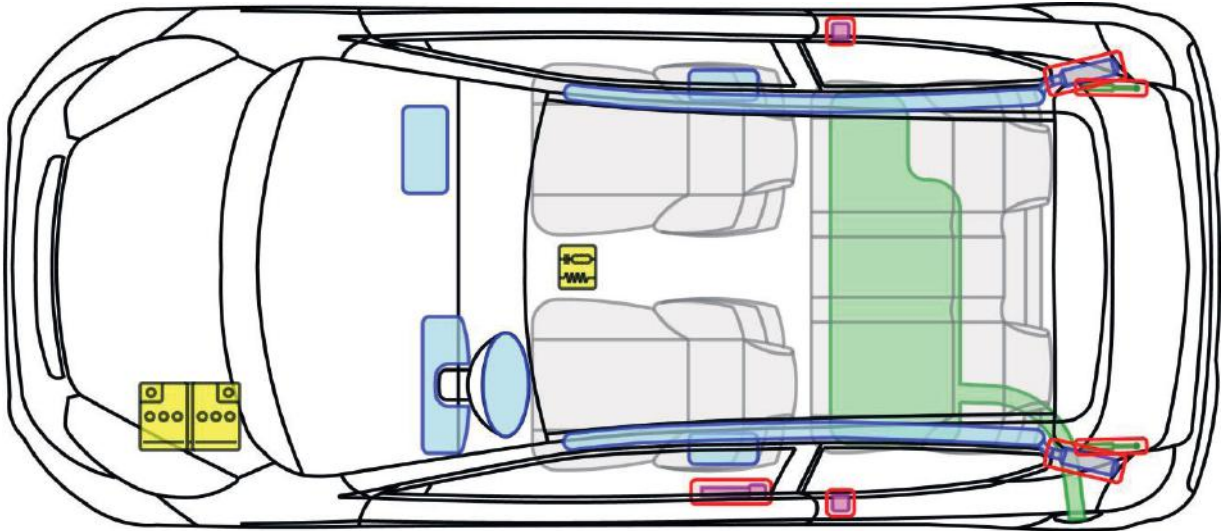

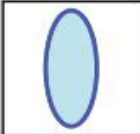

Picanto (TA)

3-Türer, 2011-2017
inklusive Facelift



Legende

	Airbag		Karosserie- verstärkung		Steuergerät
	Gas- generator		Überroll- schutz		Batterie
	Gurt- straffer		Gasdruck- dämpfer		Kraftstoff- tank

Picanto



Picanto (SA)

2004-2011

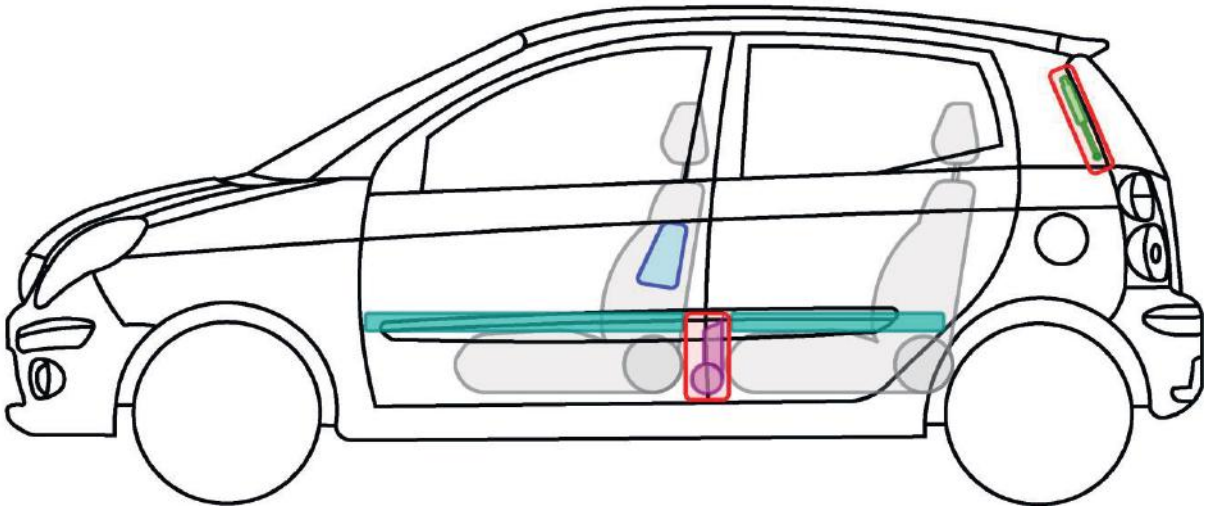
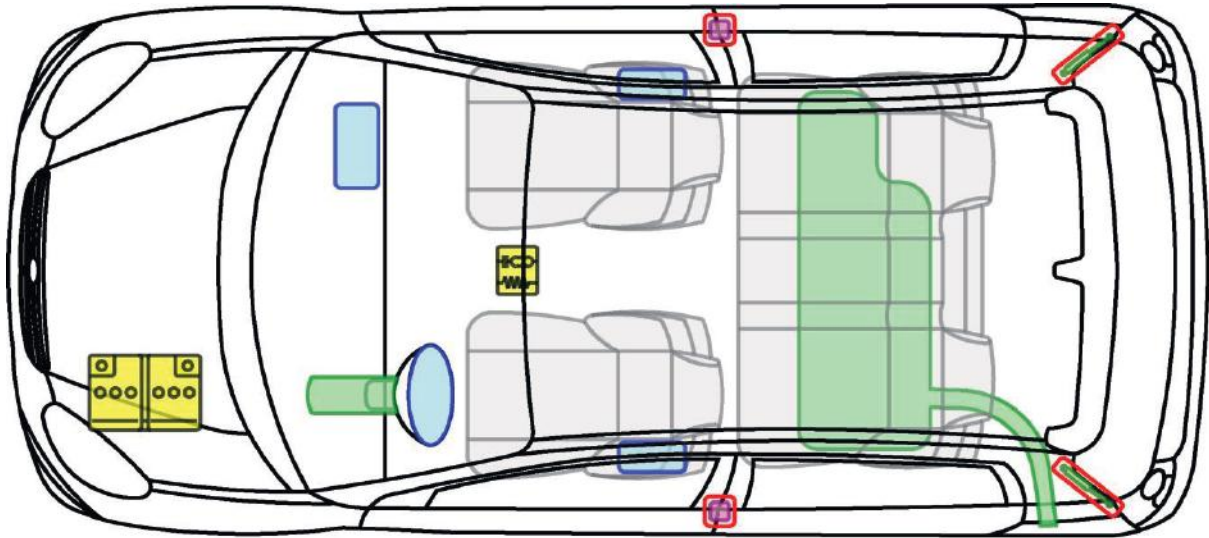

Legende

	Airbag		Karosserie-verstärkung		Steuergerät
	Gas-generator		Überroll-schutz		Batterie
	Gurt-traffer		Gasdruck-dämpfer		Kraftstoff-tank

Picanto



Rettungsdatenblätter

Diese Rettungsdatenblätter dienen ausschließlich Einsatzkräften auf dem Gebiet der technischen Hilfeleistung.

Alle auf den Rettungsdatenblättern enthaltenen Informationen sind ausschließlich für Fahrzeuge, welche für den europäischen Markt bestimmt sind. In den Rettungsdatenblättern ist immer die maximal mögliche Ausstattung der Fahrzeuge gezeigt.

Rechtsgelenkte Fahrzeuge können Bauart bedingt abweichen.

Fahrzeuge und Ausstattungsvarianten unterliegen ständigen Änderungen. KIA behält sich das Recht vor, Konstruktionen und Spezifikationen jederzeit ohne Ankündigung und ohne Übernahme eine Verpflichtung auslaufen zu lassen oder zu ändern.

Hinweis:

Diese Informationen sind ausschließlich für geschulte Einsatzkräfte und nicht für Endkunden, Werkstätten und Händler bestimmt.